



<https://engwe-bikes-eu.com>  
<https://engwe-bikes.com>

**P26**

CAUTION READ THIS MANUAL BEFORE USING YOUR EQUIPMENT

Bike Components

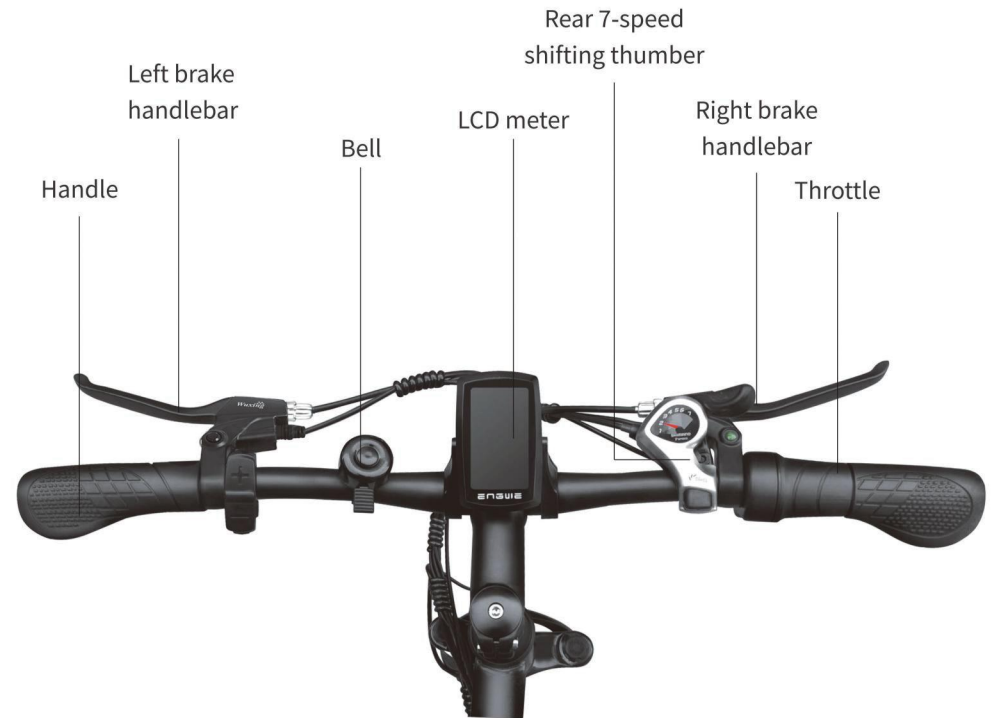

Performance index	Project	US	EU
Basic Parameters	Vehicle Size	1730*190*1120	1730*190*1120
	Wheel Size	26Inches	26Inches
	Body Material	Aluminium alloy	Aluminium alloy
	Maximum Load	220 lbs(100KG)	220 lbs(100KG)
	Vehicle Weight	53.3lbs(24.2KG)	57.7lbs(26.2KG)
Main Parameters of the Whole Vehicle	Maximum Speed	28mph(45km/h)	15.5mph(25km/h)
	Maximum Gradient	7°	7°
	Rear Derailleur	7-Speed	7-Speed
	Mileage Range	28 miles(45km)	40 miles(65km)
	Working Temperature	23°F-95°F(-5 ~35 )	23°F-95°F(-5 ~35 )
Battery Parameters	Rated Voltage	48V	36V
	Battery Capacity	13.6AH	17AH
	Service Life	500 Times	500 Times
Motor Parameters	Motor Power	500W	250W
	Motor Type	Brushless Gear Motor	Brushless Gear Motor
	Maximum Torque	55Nm	45Nm
Charger Parameters	Input Voltage	100-240V	100-240V
	Output Voltage	54V	42V
	Output Current	2A	2A

(1)EU



(2)US



The European version has shelves and mudguards, while the American version does not.

## Unwrap your ENGWE e-bike



- (1) Take out the bike, the seatpost, and the tool box.
- (2) Remove (and recycle) all wrapping material.
- (3) Save the bike box and tool box for future use.

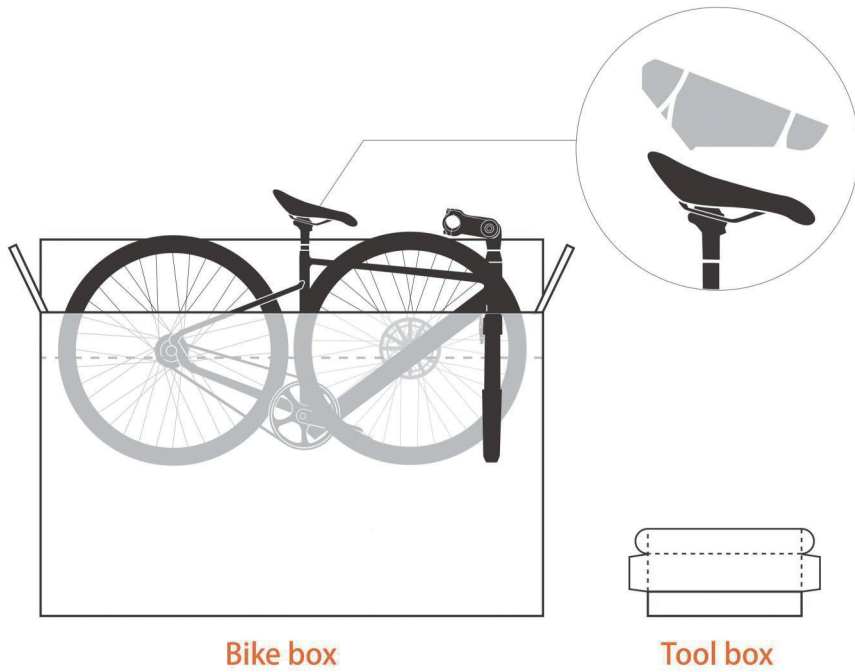

## Tool box checklist

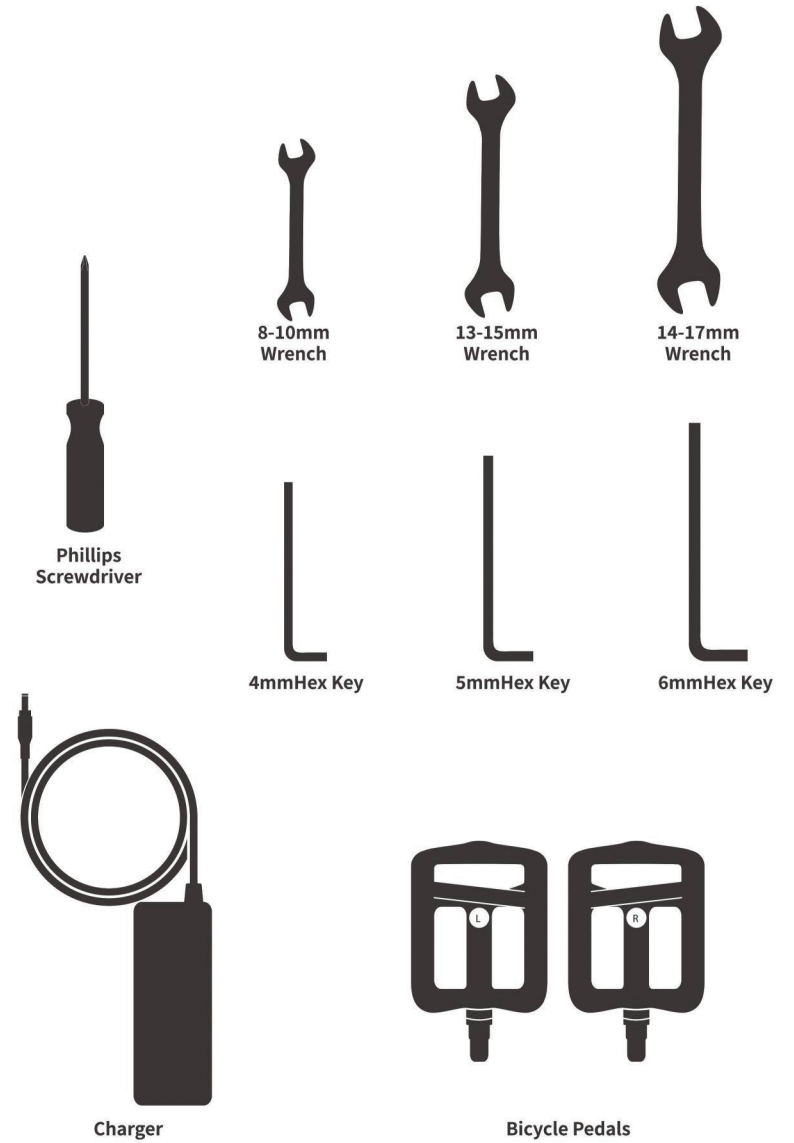

## Take out the front wheel



(1) Take out the front wheel.



(2) Remove (and recycle) the plastic covers from both sides of the wheel hub.

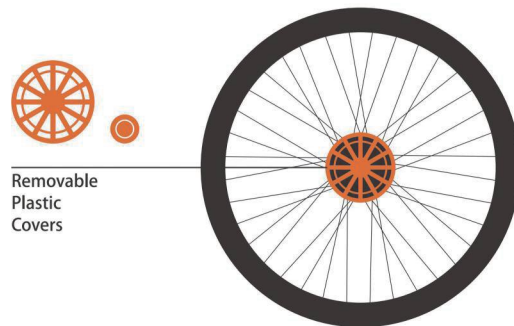

## Rotate the stem to the front



(1) Hold the head tube in one hand.



(2) Use the other hand to rotate the stem to the front-facing direction.

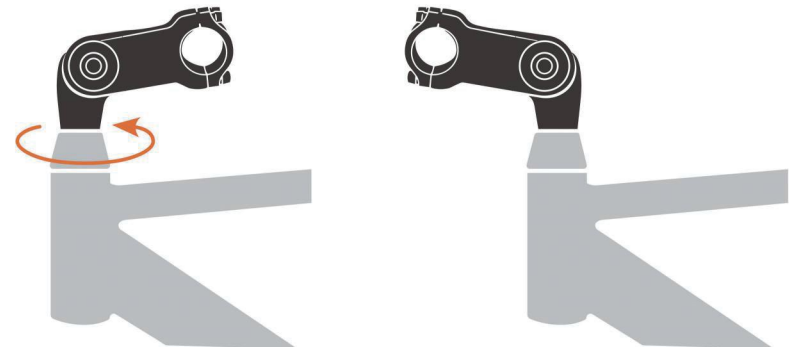

## Take off the front attachment of the stem



- (1) Use a 4mm hex key to unscrew the 4 handlebar clamp bolts by turning counterclockwise.

⚠ Be careful not to lose the bolt washers.

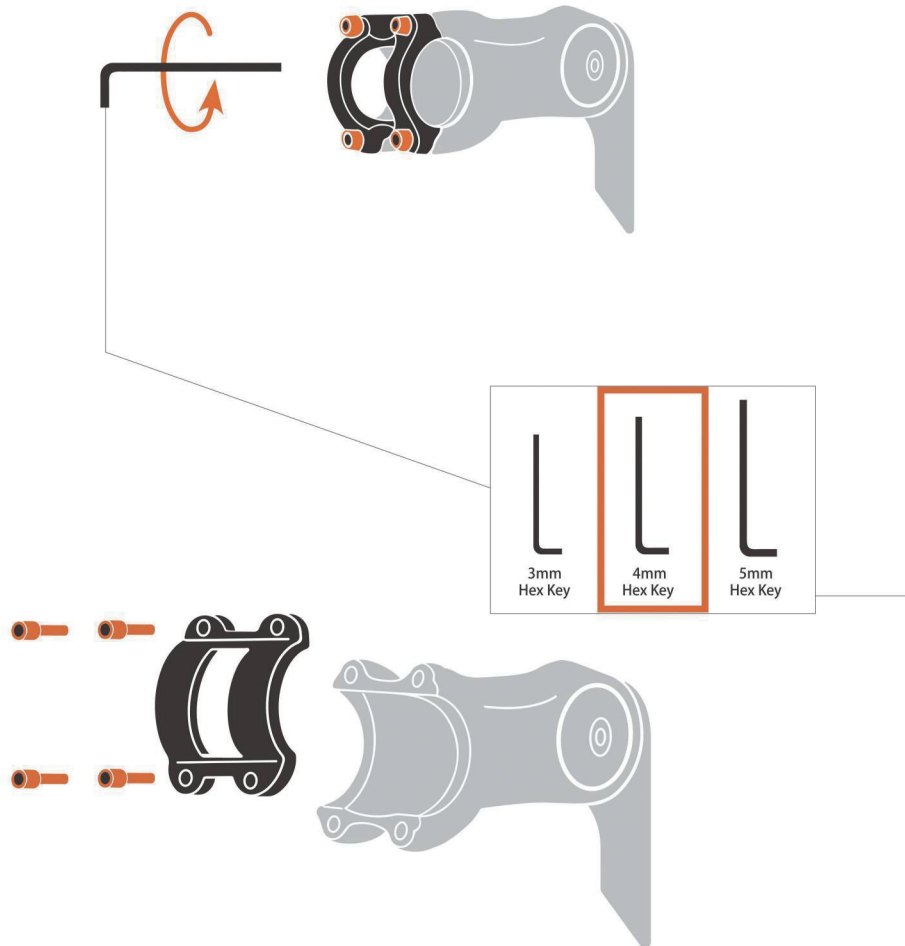

## Install the handlebar



- (1) Place the handlebar at an appropriate position, make sure the "cross symbol" is located at the center.

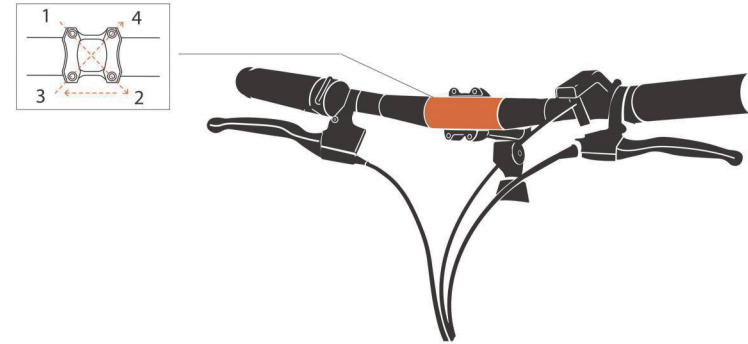

- (2) Use a 4mm hex key to install the 4 bolts by turning clockwise. The sequence is shown in the picture above. Please do not fully tighten them yet.

- (3) Once the bolts and the handlebar are in the right place, tighten the bolts fully with appropriate force.

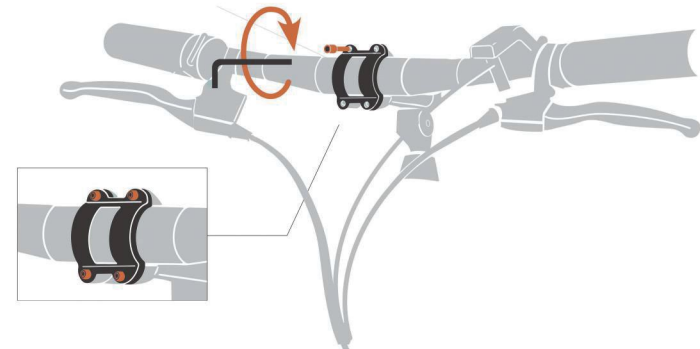

## Install the front light



- (1) Rotate the front light to the upright position.
- (2) Use a wrench to secure the front of the mounting bolt of the lamp.

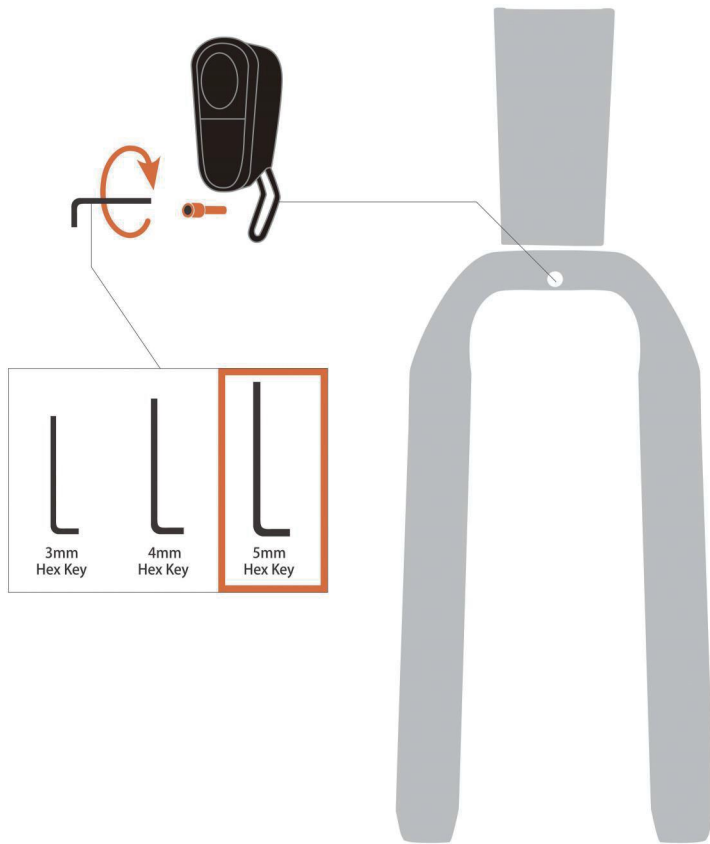

## Install the front wheel



 This step is extremely important, so please read carefully.

- (1) Clamp the front wheel with the front fork and lock the front wheel screw with a wrench.

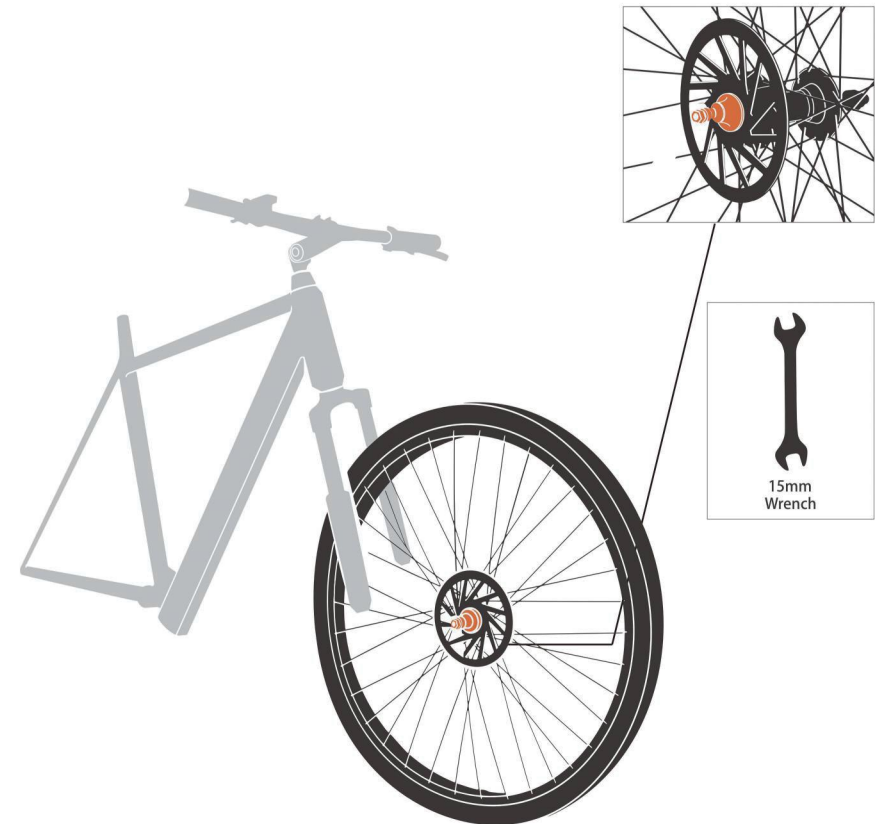



## Install the pedals



- (1) The pedals are marked with "R" (Right) and "L" (Left). This refers to the two sides of the e-bike. The R pedal goes to the side of the carbon belt, and the L pedal goes to the other side.



- (2) Manually install the left pedal by turning counterclockwise. Tighten the pedal securely with a 15mm wrench.
- (3) Manually install the right pedal by turning clockwise. Tighten the pedal securely with a 15mm wrench.

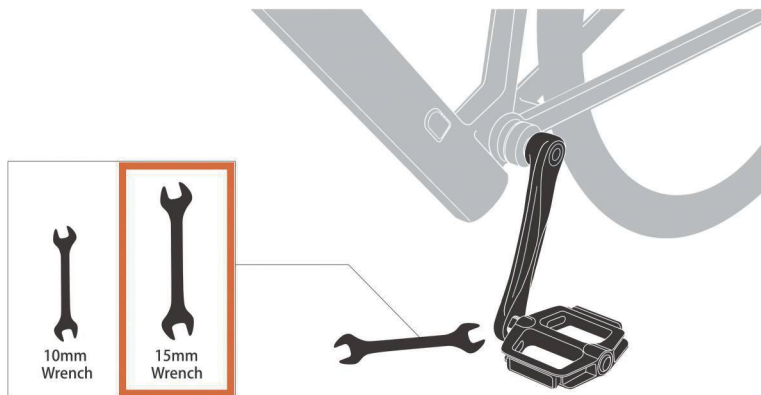

## Instrument instructions



### 1. Product name and model

Intelligent LCD display for e-bike; model: YL80C.

### 2. Specifications

- 36V/48V power supply
- Rated working current 15mA
- Maximum working current 30mA
- Leakage current at power-off <1uA
- Working current at the supply controller end 50mA
- Working temperature -20~60°C
- Storage temperature -30~70°C

### 3. Appearance and dimensions



Fig. 3-1 Picture of Display 80C



Fig. 3-2 Picture of Display 80C Buttons



## Instrument instructions

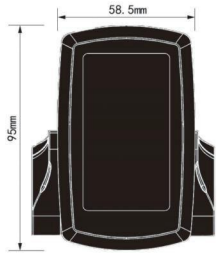

Fig. 3-3 Front View of Display 80C Dimensions



Fig. 3-4 Side View of Display 80C Dimensions

### 4. Function overview and functional area layout

#### 4.1 Function overview

Display YL80C provides a variety of functions to meet your riding needs, including:

- Battery level indicator
- Motor power indicator
- Assist level adjustment and indication
- Speed indicator (including real-time speed, maximum speed and average speed)
- Distance indicator (including trip distance and ODO)
- Push assistance control and indication
- Headlight control and indication
- Error code indicator
- USB connection indicator (reserved)
- Heart rate indicator (reserved)
- Bluetooth connection indicator (reserved)
- Custom parameter setting (e.g., wheel diameter, speed limit, battery level, assist level, power-on password, controller current limit, etc.)
- Reset function

#### 4.2 Functional area layout

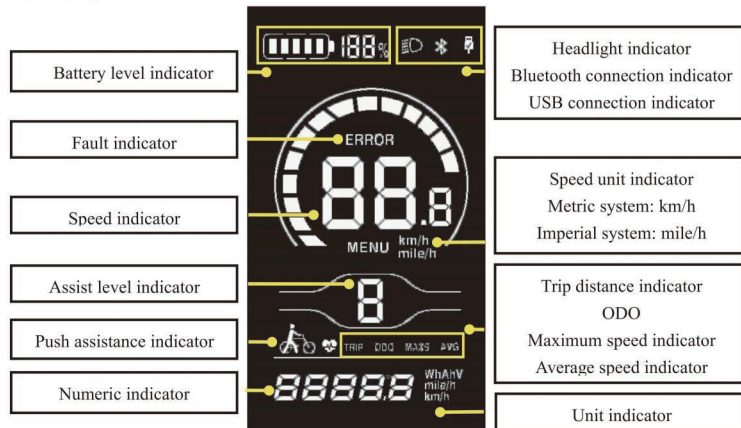







Fig. 4-1 Functional Area Layout Interface of Display YL80C

## Instrument instructions





### 4.3 Button definitions

There are five buttons on the operating unit of display YL80C, i.e., the on/off button , plus button , minus button , headlight button  and switching button .

### 5. General operation

#### 5.1 Power on/off

By pressing and holding the button , the display will start to work and the working power supply of the controller will be turned on. In the power-on state, by pressing the button , your e-bike will be powered off. In the power-off state, the display will no longer use the battery power, and its leakage current will be less than 1uA.

■ If your e-bike is not used for more than 10 minutes, the display will be automatically powered off.

#### 5.2 Display interface

After the display is turned on, the display will show the real-time speed (km/h) and the trip distance (km) by default.

By pressing the button , the information displayed will be switched between the trip distance (km), ODO (km), maximum speed (km/h), average speed (km/h) and riding power.

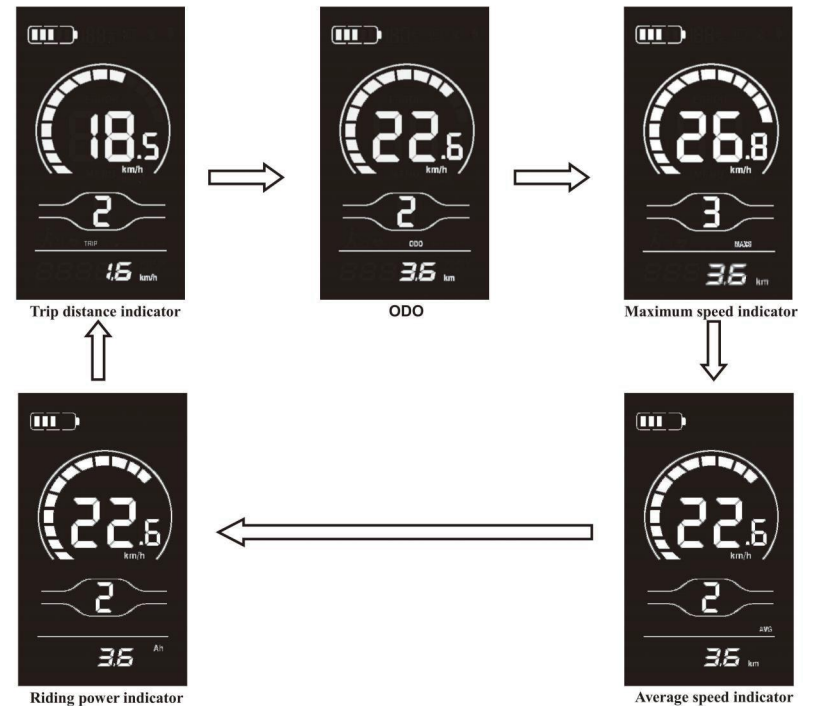

Fig. 5-1 Display Interface Switching

5.3 Push assistance





By pressing and holding the button , the electric push assistance mode will be enabled. Your e-bike will run at the constant speed of 6km/h. The display will show . By releasing the button , your e-bike will immediately stop power output and return to the state before push assistance.



Fig. 5-2 Push Assistance Indicator Interface

■ The push assistance function can only be used when you are pushing your e-bike. Please do not use it during riding.

5.4 Headlight on/off

By pressing the button , the controller will turn on the headlights and the display backlight will turn dark; by pressing the button  again, the controller will turn off the headlights and the display backlight will resumes the luminance.

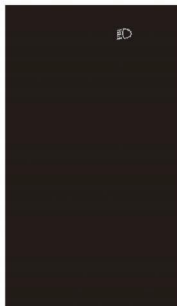



Fig. 5-3 Backlight-on Indication Interface

5.5 Assist level selection

By pressing the button , the e-bike assist level will be switched to change the motor output power.

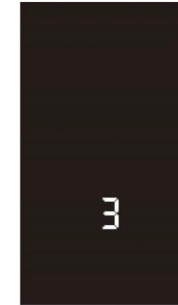

Fig. 5-4 Assist Level Switching Interface

5.6 Battery level indicator

The battery level indicator consists of five segments. When the battery is fully charged, the five segments will be all on. In case of undervoltage, the outline of the battery indicator will flash, which means the battery has to be charged immediately.



Full battery level indication    4-segment indication    3-segment indication    2-segment indication    1-segment indication



Undervoltage flashing

Fig. 5-5 Battery Level Indicator Interface

5.7 Motor power indicator

The display can indicate the output power of the motor, as shown in the figure below.



Fig. 5-6 Motor Power Indicator Interface

5.8 Error code indicator

When a fault occurs in the electronic control system of your e-bike, the display will automatically indicate the error code. Detailed definitions of error codes are shown in **Schedule 1**.



Fig. 5-7 Error Code Indicator Interface

■ When an error code appears on the display interface, please conduct troubleshooting in time. Otherwise, your e-bike will not work normally.

## 6. General setting

■ All parameters can only be set when your e-bike stops.

The steps for general setting are as follows:

In the power-on state, when the display shows the speed of 0,

(1) Press and hold the buttons **+** and **-** at the same time for more than 2 seconds to enter the selection interface of general setting options;

(2) Press the button **+/-** to switch the selection interface of general setting options, and press the button **i** to enter the parameter modification interface;

(3) Press the button **+** / **-** for parameter selection;

(4) Press the button **i** to save the parameter and return to the selection interface of general setting options;

(5) Press and hold the button **i** to save the parameter and exit the selection interface of general setting options.

The following selection interfaces of general setting options are available:

### 6.1 Trip distance reset

tC refers to the trip distance reset item. tC-n means not to reset the trip distance, and tC-y means to reset the trip distance.

Press the button **i** to enter the parameter modification interface. Press the button **+/-** for parameter selection.

Press the button **i** to save the parameter and return to the selection interface of general setting options.



Fig. 6-1 Trip Distance Reset Interface

### 6.2 Backlight luminance setting

bL refers to the backlight luminance setting option. Parameters bL-1, bL-2 and bL-3 are available, which represent the backlight luminance, 1 for the minimum luminance, 2 for the standard luminance and 3 for the maximum luminance.

Press the button **i** to enter the parameter modification interface. Press the button **+/-** for parameter selection.

Press the button **i** to save the parameter and return to the selection interface of general setting options.



Fig. 6-2 Backlight Luminance Setting Interface

### 6.3 Metric/imperial system setting

Un refers to the metric/imperial system setting option. U-1 represents the imperial system, and U-2 represents the metric system.

Press the button **i** to enter the parameter modification interface. Press the button **+/-** for parameter selection.

Press the button **i** to save the parameter and return to the selection interface of general setting options.



Fig. 6-3 Imperial System Setting Interface











Fig. 6-4 Metric System Setting Interface

## 7. General parameter setting

The steps for general parameter setting are as follows:

In the power-on state, when the display shows the speed of 0,

- (1) Press and hold the buttons  /  at the same time for more than 2 seconds to enter the selection interface of general setting options;
- (2) Press and hold the buttons  and  at the same time for more than 2 seconds to enter the selection interface of general parameter setting options;
- (3) Press the button  to switch the function, and press the button  to enter the parameter modification interface;
- (4) Press the button  for parameter selection;
- (5) Press the button  to save the parameter and enter the next selection interface of general parameter setting options;
- (6) Press and hold the button  to save the parameter and exit the selection interface of general parameter setting options.

### 7.1 Wheel diameter setting

Ld refers to the wheel diameter setting option. Available parameters include: 8-26, 700C, 28-30 inches.



Press the button  to enter the parameter modification interface. Press the button  to select the wheel diameter corresponding to your e-bike (to ensure the accuracy of the speed and distance indication of the display). Press the button  to save the parameter and enter the next selection interface of general parameter setting options.



Fig. 7-1 Wheel Diameter Setting Interface

### 7.2 Speed limit setting

LS refers to the speed limit setting option. By modifying this value, you can set the maximum riding speed of your e-bike. The selectable range of the maximum speed setting value is 12km/h-40km/h.



Press the button  to enter the parameter modification interface. Press the button  to select the maximum riding speed. Press the button  to save the parameter and enter the next selection interface of general parameter setting options.



Fig. 7-2 Speed Limit Setting Interface

## 8. Custom setting

In order to meet the individual requirements of customers, custom setting options are available, including: battery level setting of the display, assistance parameter setting, current limit setting, assistance sensor setting, speed sensor setting, handlebar function setting, system setting and power-on password setting, totally eight setting options. **Not all protocols support the custom setting options of display YL80C. Some protocols only support part of the setting options.**



Press the button  to switch the level. Press the button  to confirm the level mode and enter the 8.2.2 assistance ratio setting option, or press and hold the button  to confirm the setting and return to the selection interface of custom setting options.



Fig. Assist Level Selection Interface

### 8.1 Assistance sensor setting (option)

#### 8.1.1 Assistance sensor sensitivity setting

SCN refers to the assistance sensor sensitivity setting option. The setting range is 2-9, where 2 means the maximum sensitivity and 9 means the minimum sensitivity.

Press the button **+**/**-** to select the assistance sensor sensitivity. Press the button **i** to confirm the parameter and enter the 8.4.3 steel magnet number setting option for assistance magnetic disk, or press and hold the button **i** to confirm the parameter and return to the selection interface of custom setting options.



Fig. Assistance sensor sensitivity setting interface



Fig. Button Push Assistance Enable Setting Interface

### 8.2 Power-on password setting (option)

#### 8.2.1 Power-on password enable setting

By inputting the password, you can enter the password enable setting option. PSd-Y means that a power-on password is required, and PSd-N means that no power-on passwords are required.

Press the button **+**/**-** for parameter selection.

If you select PSd-N, press the button **i** to confirm the parameter and return to the selection interface of custom setting options. If you select PSd-Y, press the button **i** to enter the 8.8.2 power-on password modification setting option, or press and hold the button **i** to confirm the parameter and return to the selection interface of custom setting options.



Fig. 8-15 Password Enable Confirmation Interface

#### 8.2.2 Power-on password modification setting

P3 refers to the power-on password modification setting option. Press the button **i** for cursor movement and the button **+**/**-** for parameter selection. After the modification, press and hold the button **i** to save and confirm the parameter and return to the selection interface of custom setting options. If the display is rebooted, it will show P1, 0000, and it will not work normally until you enter the correct password.



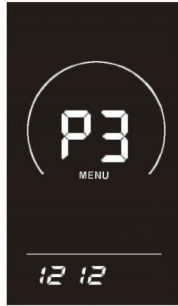

Fig. 8-16 Password Modification Interface

### 9. Restore default settings

dEF refers to the setting option of restoring default parameters. dEF-Y means that the default settings need to be restored, and dEF-N means that there is no need to restore the default settings. In the normal display interface, press and hold the buttons **+** and **i** at the same time for more than 2 seconds to enter the restore default settings interface. Switch the parameter by pressing the button **+**/**-**. If you choose Y, press and press the button **i** to confirm the parameter. The display will indicate dEF-0 and automatically start to restore the default settings. After the restoration is completed, it will automatically exit and return to the normal display interface.



Fig. 9-1 Interface of Restore Default Settings

### 10. Quality commitments and warranty scope

#### 10.1 Warranty information:

- For the faults caused by the quality of the product under normal use, the Company will be responsible for providing limited warranty during the warranty period.
- The warranty period of the product is within 12 months from delivery.

#### 10.2 Non-warranty scope

- The enclosure is opened
- The connector is damaged
- The enclosure is scratched or damaged after delivery
- The outgoing line of the display is scratched or broken
- Faults or damage caused by force majeure (such as fires, earthquakes, etc.) or natural disasters (such as lightning strikes, etc.)
- The warranty period has expired

### 11. Outgoing line connection diagram

#### 11.1 Wiring sequence of standard connector

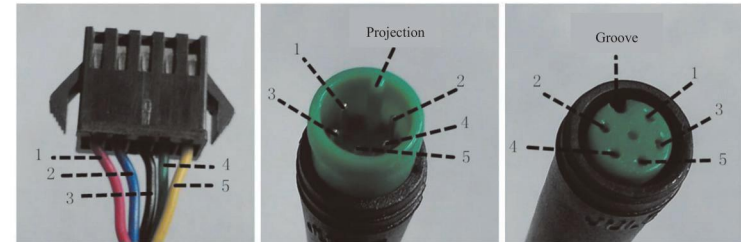

Connecting terminal to the controller      Leading-out terminal of display      Connecting terminal

Fig. 8-1 Outgoing Line Connection Diagram

Table 8-1 Wiring Sequence of Standard Connector

Standard wiring sequence	Standard wire color	Function
1	Red (VCC)	Power cord of display
2	Blue (Kp)	Power control line of controller
3	Black (GND)	Ground wire of display
4	Green (RX)	Data receiving line of display
5	Yellow (TX)	Data transmission line of display

■ The outgoing lines of some products adopt waterproof connectors, and users cannot see the outgoing line color inside the wire harnesses.



## 12. Considerations

Please use safely, and do not plug or unplug the display when it is powered on.

◆ Please avoid bumping as far as possible.

◆ Please do not alter the background parameter settings of the display at will, otherwise normal riding cannot be guaranteed.

◆ If the display fails to work normally, it should be repaired as soon as possible.

◆ Due to product upgrades of the Company, part of the displayed contents or functions of the product you bought may be different from the manual, depending on the actual model.

### Schedule 1 Error Code Definitions

Fault codes for protocols YL-01 and YL-02:			
Fault code	Fault description	Fault code	Fault description
E001	Controller failure	E004	Handlebar failure
E002	Communication failure	E005	Brake lever failure
E003	Hall element failure	E006	Default phase of motor
Fault codes for protocols YL-05, KDS and YL-J:			
Fault code	Fault description	Fault code	Fault description
E021	Abnormal current	E024	Hall element failure
E022	Handlebar failure	E025	Brake failure
E023	Default phase of motor	E030	Communication failure

### Schedule 2: Assist Level Ratio Default Values

Assist level selection \ Assist level	1	2	3	4	5	6	7	8	9
0-3/1-3	50%	74%	92%	—	—	—	—	—	—
0-5/ 1-5	50%	61%	73%	85%	96%	—	—	—	—
0-7/ 1-7	40%	50%	60%	70%	80%	90%	96%	—	—
0-9/ 1-9	25%	34%	43%	52%	61%	70%	79%	88%	96%

Tel: 022-86838795

Fax: 022-86838795

Email: yolin@yolintech.com

Website: www.yolintech.com

Address: Plant 52-1, Yougu Xinke Park, East of Jingfu Road, Pharmaceuticals and Medical Equipment Industrial Park, Beichen Economic Development Zone, Beichen District, Tianjin

● How far full charge battery can go? That depends on the loading weight, road condition and battery capacity. But in the same condition, average speeds can continuous longer travel range.

● When storing the battery for a longer time, (during winter time) it is important to place the fully charged battery in a dry place.

● Attention: The battery should be re-charged once every 2-3 month when it is not used.

### WARNING:

● Keep the battery out of reach for children.

● Never try to open the battery.

● Only use the ENGWE supplied battery. Do not use a battery from any other different product models.

● If the battery is damaged because it has been dropped somewhere or biking accident, there may be a risk of electrolytes leakage. Beware of chemical burns! And immediately stop using the damaged battery.

● Do not touch the battery without a cloth or gloves and make sure no acid touches your eyes.

● Do not store the battery in temperatures above 95F or below 23°F.

● Do not allow the battery to run down completely before charging. Charge the battery before storing the product. If the battery is completely empty, it may cause the battery to no longer charge.

● Charge a new battery for at least 4-6 hours before you use it in your product for the first time. Never charge the battery too long per time. Overheating or undercharging the battery may shorten battery life and decrease product run time.



### IMPORTANT: BATTERY DISPOSAL

● Battery must be recycled or disposed of in an environmentally sound manner.

● Do not dispose of the battery in a fire. The battery may explode or leak.

● Do not dispose of a battery in your regular household trash.

## Charging



- How far full charge battery can go? That depends on the loading weight, road condition and battery capacity. But in the same condition, average speeds can continuous longer travel range.
- You can charge the bike directly, or you can remove the battery for charging.
- The RED light indicates it is in charging and GREEN light indicates the battery is fully charged. (Please put off plug from wall) Usually the charging time is 4-6 hours depends on the battery capacity remain.

### WARNING:

- Charging time over 10 hours is prohibited please kept it away from high temperature environment and stores it in a cool place.
- Please make sure that the battery charger and charging plug are always kept dry and never get wet.
- The charger should only be cleaned with a dry cloth. Never use a wet cloth, oil or any other liquid.
- Do not connect positive and negative terminals.
- Stop the charging procedure immediately if you notice anything unusual.
- It is strictly forbidden to cut the battery charging and discharging lines.
- It is strictly forbidden to disassemble the battery box or modify the internal structure and protection board of the lithium battery.
- It is strictly forbidden to disassemble the battery box or modify the internal structure and protection board of the lithium battery.
- Only use the ENGWE supplied charger. Do not use a charger from any other different product models.
- After using the battery, please charge it within 12 hours.

If the product has problems with the following forms during the protection period, we will provide customer service as part of the product quality guarantee.

## Quality Assurance



Accessories	quality problem	Warranty period	service content
Motor	Motor will not be able to use	1 year	Free delivery of parts
Accelerator	Natural conditions (such as impact force cannot be used except damage)	1 year	Free delivery of parts
Controller	Failure occurs under normal use	1 year	Free delivery of parts
Charger	Failure occurs under normal use	1 year	Free delivery of parts
Lithium Battery	Can't charge discharge under normal use	1 year	Free delivery of parts

### Notes:

If the above issues occur during the protection period, please contact us and send us photos or videos of the defective parts. If we confirm that the fault is caused by the quality of the product itself, we will send you the parts that are needed replaced for free.

### Year Limited Hardware Warranty

Your ENGWE Electric bike includes a One Year Limited Hardware Warranty. The Warranty covers product defects in materials and workmanship under normal use. This Warranty is limited to original purchasers. This Warranty starts on the date of your purchase and lasts for one year (the "Warranty Period"). The Warranty Period is not extended if the Product is repaired or replaced.

Warranty services are provided by the e-bike. If a hardware defect arises and a valid claim is received within the Warranty Period, at its option and to the extent permitted by law, ENGWE will resend new parts that are equivalent to new in performance and reliability. This Warranty is not assignable or transferable. The original purchaser may contact us for service request.

This Warranty does not cover any damage due to: improper use; failure to follow the product instructions or to perform any preventive maintenance; unauthorized repair; external causes such as accidents, abuse, or other actions or events beyond our reasonable control.

🔊 Any question about the item, please contact the customer service from where you brought your device.